

# S41

The Allrounder  
for complex grinding jobs.



## Key data

The S41 is a CNC universal cylindrical grinding machine for large workpieces. It has distances between centres of 1000 / 1600 mm and centre heights of 225 / 275 mm. It can machine workpieces with a maximum weight of 250 kg.



GLOBAL  
TECHNOLOGIE LEADER  
PERFECTION  
CUSTOMER FOCUS  
EFFICIENCY  
SAFETY  
SOPHISTICATED PROCESSES  
PRECISION

**The Art of Grinding.**

TECHNOLOGIE LEADER  
EFFICIENCY  
PERFECTION  
CUSTOMER FOCUS  
PRECISION  
GLOBAL  
SOPHISTICATED PROCESSES  
SAFETY

### Fritz Studer AG

---

The name STUDER stands for more than 100 years of experience in the development and production of precision cylindrical grinding machines. «The Art of Grinding.» is our passion, highest precision is our aim and top Swiss quality is our benchmark.

Our product line includes both standard machines, as well as complex system solutions in high-precision cylindrical grinding for machining small and medium-sized workpieces. In addition we offer software, system integration and a wide range of services. As well as receiving a complete tailor-made solution the customer also benefits from our 100 years of know-how in relation to the grinding process.

Our customers include companies from the machine tool industry, automotive engineering, tool and die makers, the aerospace industry, pneumatics/hydraulics, electronics/electrical engineering, medical technology, the watch industry and job order production. They value maximum precision, safety, productivity and longevity. 22 000 manufactured and delivered systems make us the market leader and are clear evidence of our technological leadership in universal, external, internal and noncircular grinding. Around 800 employees, including 75 apprentices, make it their goal every day to ensure that «The Art of Grinding.» will continue to be closely linked to the name STUDER in the future.

# S41

If you think that you already know everything about grinding machines, you don't know the S41 yet. New technical developments ensure flexibility, high precision and short auxiliary times. The patented Studer-Guide® guideway system with high-precision linear drive is just one of the advantages of the S41. It also boasts further technical features: you can choose from a large number of wheelhead variants. With up to four grinding wheels, the S41 fulfils virtually every requirement in complete machining.



# Characteristics

## Dimensions

- Distance between centres 1 000 / 1 600 mm
- Centre height 225 / 275 mm
- Maximum workpiece weight 250 kg

## Hardware

- StuderGuide® guide system with linear drive
- Turret wheelhead with direct drive and 0.00005 deg resolution
- Complete machining with up to four grinding wheels
- C axis for the workhead enabling form and thread grinding
- Full enclosure with two sliding doors
- Granitan® S103 mineral-casting machine base

## Software

- Very simple operation and programming thanks to StuderWIN
- StuderGRIND programming software for the creation of grinding and dressing programs directly on the machine control, or on an external PC
- Reduced setup and resetting times with STUDER Quick-Set
- Standardized interfaces for loader and peripheral devices

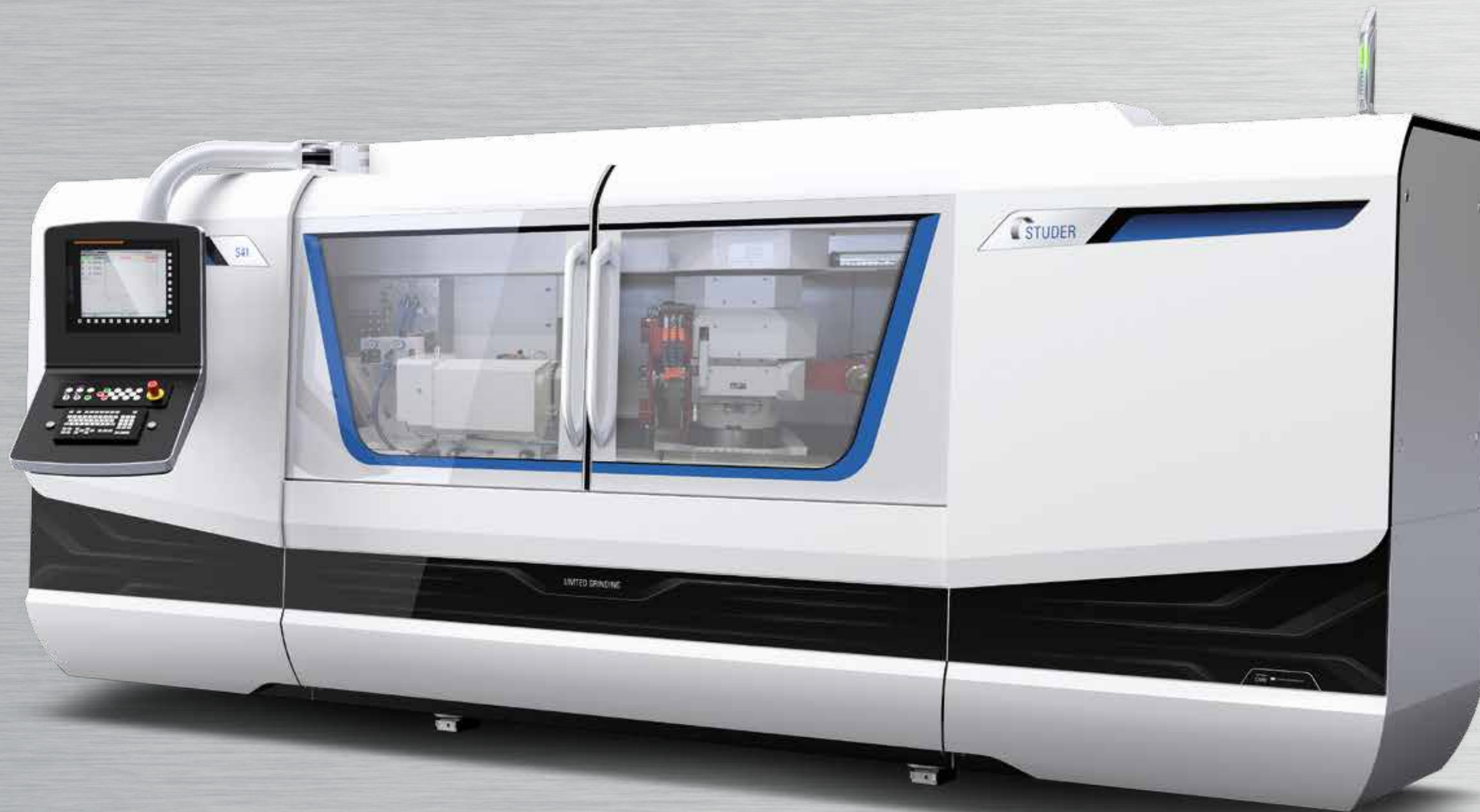

The S41 is a CNC universal cylindrical grinding machine of the latest generation. It boasts many technical features, such as the revolutionary StuderGuide® guideway system, high-precision axis drives with linear motors, extremely fast direct drive of the B-axis, an even larger selection of wheelhead variants etc..

The S41 meets every possible requirement. Thanks to the centre height of 225 or 275 mm and a distance between centres of 1 000 or 1 600 mm, the majority of daily grinding tasks can be efficiently performed on this machine. Naturally the S41 can also be configured as a single-purpose machine for large batch production. The S41 can make full use of its speed particularly in applications where short auxiliary times are important.

Precision is the result of perfect interaction between a large number of different factors. The base is the Granitan® S103 machine bed with its excellent damping characteristics and favorable thermal behavior. The modules are ideally suited to each other and produced with customary STUDER precision. The large distance between the guideways and the very rigidly constructed slides form the basis for the precision and productivity of this machine. All components involved in defining precision are temperature-stabilized.

StuderWIN as user interface and the software module by StuderGRIND create a stable programming environment and contribute to efficient use of the machine. A PC is integrated into the CNC control. The possibility of integrating the in-process gauging and sensor technology for process monitoring as well as contact detection and automatic balancing systems in the control enable standardized programming of the different systems. The software for an internal loading system is also integrated in the control. The driver elements are optimally adapted to the control.



## Granitan® S103 mineral casting machine bed

1



- Vibration-damping
- Thermally stable
- Non-wearing

The material structure developed by STUDER which has proved its superb efficiency over many years is produced in the company's own plant using the most modern industrial techniques.

The excellent dampening behavior of the machine base ensures outstanding surface quality of the ground workpieces. The service life of the grinding wheel is also increased, leading to reduced downtimes.

Temporary temperature fluctuations are extensively compensated by the favorable thermal behavior of Granitan®. This provides high stability throughout the day. The StuderGuide® guide system for the longitudinal and cross slides is moulded directly into the machine base and finished with a wear-resistant Granitan® S200 surfacing material. The guideways offer the highest possible accuracy through the entire speed range with high load capacity and dampening levels. Thanks to the robust and maintenance-free design, these excellent guideway characteristics are more or less completely retained.

2

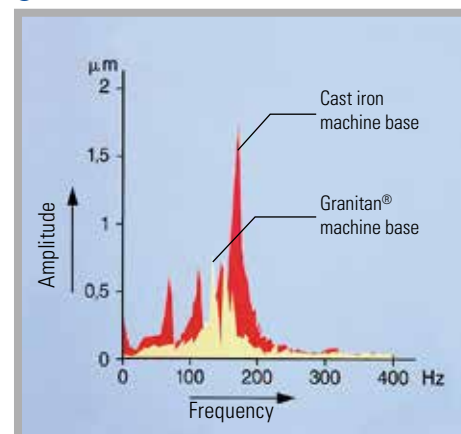

1 Machine base with X and Z guideways

2 Vibration behavior of gray cast iron and Granitan® S103

## StuderGuide® in longitudinal and cross slides

1



2

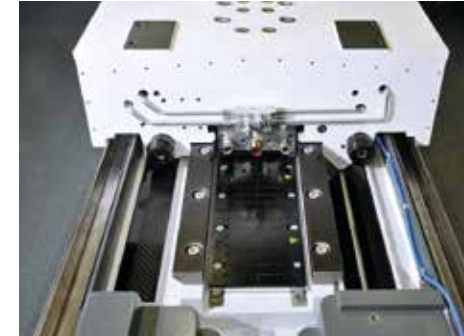

- High geometrical traverse precision
- Setup scale for setup and resetting
- Effective covering of guideways

3

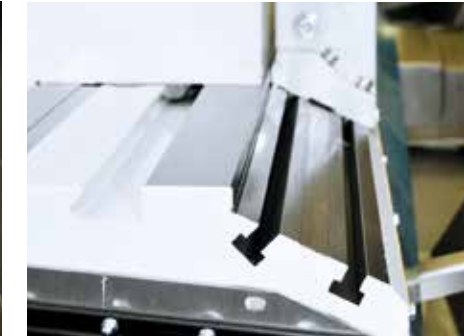

4



The longitudinal and cross slides are manufactured from high-quality gray cast iron and have highly precise, ground guideways. The slides rest completely on the guideways of the machine bed through the entire traversing range. This provides the cornerstone for the excellent straightness of 0.003 mm over 950 mm measured length. The top of the longitudinal slide has a surface that is ground over its entire length and acts as a support for the workhead, the tailstock, as well as accessories and devices. A setup scale, recessed in the table, makes it easy to set up and reset the units on the table. An additional T-slot with a ground surface enables the optimal utilization of dressing devices. The newly developed StuderGuide® guide system extends the advantages of hydrostatic systems and guideways with

patented surface structure. A huge advantage of StuderGuide® over hydrostatic guideways is the damping component in the movement direction. The slides are powered by linear motors with direct measuring systems with a resolution of 10 nanometers. The maximum travel speed for both axes is 20 m/min. This lays the basis for high-precision and efficient grinding with the shortest possible auxiliary times. The combination of StuderGuide®, linear motors and direct measuring systems guarantees the highest interpolation accuracies.

1 Machine base with longitudinal and cross slides

2 X-axis with linear motor

3 Double T-slot and clamping surface for mounting dressing tool holders etc.

4 Setup scale

## Turret wheelhead



- Configurable in accordance with customer's requirements
- Complete machining
- Grinding of cylindrical and conical parts with the same grinding wheel

The most important component for complete machining is the wheelhead with integrated B-axis. It swivels automatically, and enables the use of up to four grinding wheels. This means that workpieces can be completely machined in the same clamping – with minimal auxiliary times combined with superior precision.

This B axis has a direct drive, which positions very quickly and precisely. The high-resolution direct measuring system guarantees a positioning range of the high-precision B-axis < 1".

- 1 Turret wheelhead left / right / internal  
2 Automatic A-axis  
3 HSG spindle

- 4 Positioning probe horizontal to the work plane

## Wheelhead variants

## Universal

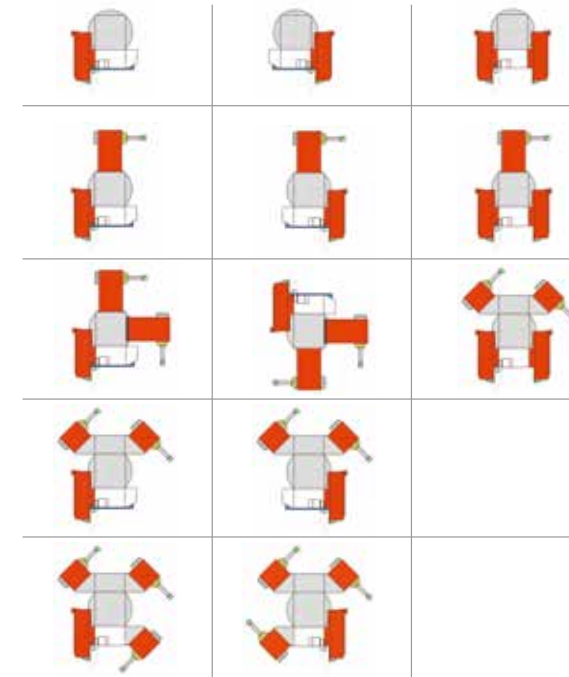

## Tandem

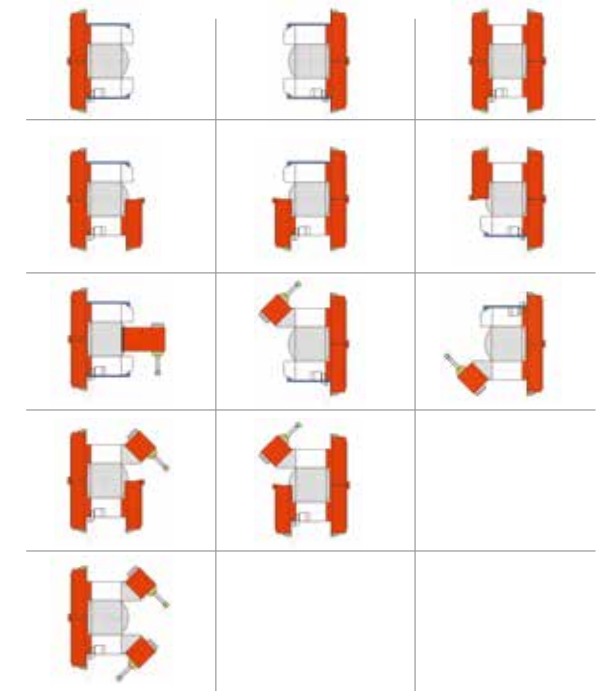

## Diagonal

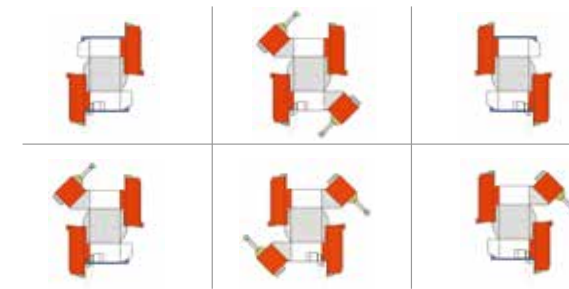

## Internal grinding

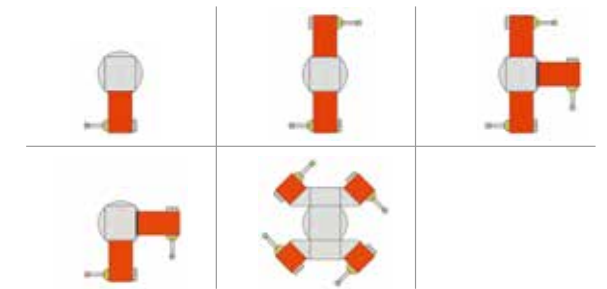

Combinations of up to four external or internal grinding spindles result in more than 30 basic variants. Internal grinding spindles with 6000 rpm to 120000 rpm can be used. Automatic balancing systems and frequency converters for the individual external grinding spindles enable even better coordination of the wheelhead variants with the grinding process. A vertical spindle for grinding splines or a longitudinal grinding axis for non-interpolating traverse grinding of internal tapers can also be mounted on the wheelhead as a special solution.

**Automatic A-axis**

STUDER offers an automatically swiveling A-axis on the S41 for efficient, high-precision thread grinding. The swivel angle is  $\pm 15$  deg. Even greater pitch angles can be achieved with the aid of StuderThread, thanks to profile error compensation. There is one model for standard and one for HSG for external grinding and one model for internal grinding. Max. two A-axes are possible.



# Workhead



- High roundness accuracy
- Low-maintenance
- Air cushion

The versatile universal workhead enables both live spindle grinding and grinding between centres. The machine can also be fitted with a specially designed chuck workhead for chuck applications. The workheads are mounted on roller bearings, are low-maintenance and possess an excellent roundness accuracy of below 0.0004 mm (optionally 0.0002 mm) during live spindle grinding operations. The fine adjustment allows for cylindricity corrections in the 1 µm range during live spindle operations. Like the tailstock, the workhead is also equipped with an air cushion lift-off to simplify movement during setup and resetting.

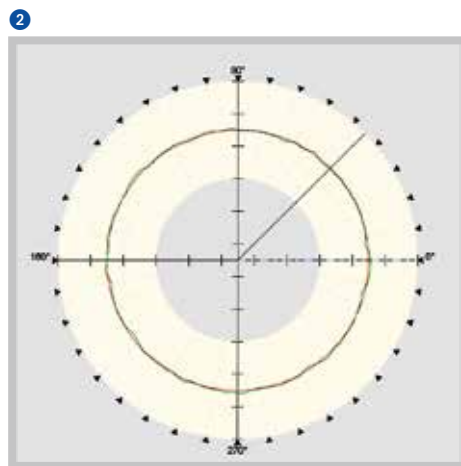

- 1 Universal workhead
- 2 Roundness accuracy (test certificate)
- 3 Fine adjustment for cylindricity corrections

# Direct-drive workhead

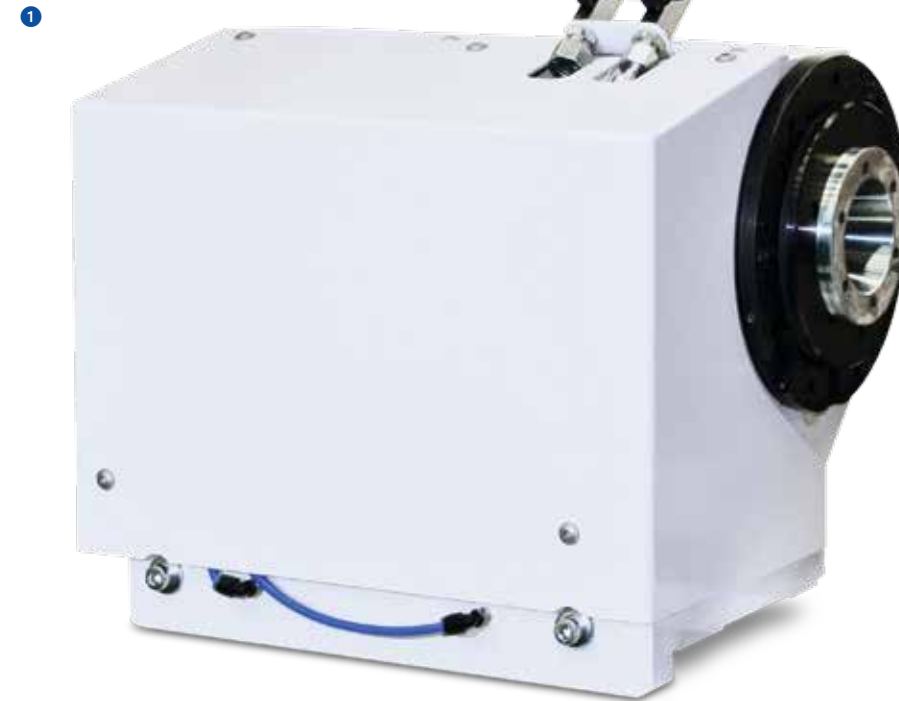

The direct-drive workhead is primarily used for live spindle grinding of heavy workpieces and for high-precision C-axis applications. With form grinding, the spectrum of parts is expanded by the design configuration of the direct drive. The design also allows the installation of a high-precision measuring system directly on the spindle. This workhead does not have a fixed centre.

# C-axis for form and thread grinding

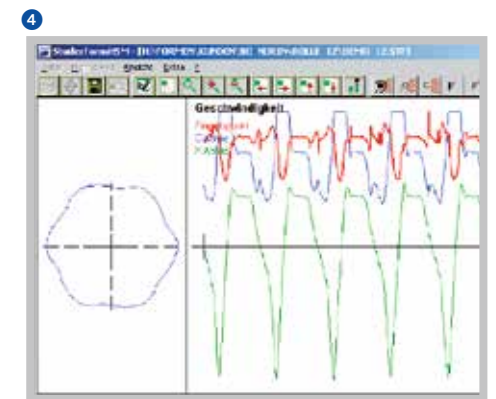

Complete machining also entails form and thread grinding operations to an ever increasing extent. These processes are made possible by the position and speed-controlled C-axis. The standard C-axis with measuring system on the drive motor is suitable for thread grinding. A direct measuring system is mounted on the workhead spindle (C-axis) to ensure the highest form accuracy. Acceleration and grinding forces are absorbed without difficulty through the high dynamic rigidity of the axis drives.

### Form and thread grinding

The S41 enables axis-parallel grinding of conventional threads up to threads for high accuracy application. Polygons, excenters, control cams, cams etc. can be manufactured costeffectively and in the highest precision with High Speed Machining (HSM).

- 1 Direct-drive workhead
- 2 External and internal thread grinding
- 3 Form and die grinding

- 4 Contact ratios during form grinding

# Tailstock

1



- Cylindricity corrections
- Thermal stabilization by coolant flooding

The generously dimensioned barrel, designed for the deployment of Morse 4 taper centres, glides in the tailstock housing. The centre pressure can be adjusted with the delicate precision required for grinding high-precision workpieces. The tailstock can be equipped with a hydraulically actuated barrel retraction for workpiece changeover. The fine adjustment enables cylindricity corrections in the range below 1 µm when grinding between centres. An air cushion lift-off facilitates simple movement during setup and resetting.

A cooling lubricant is passed through the tailstock and totally covers the barrel and diamond holder, in order to guarantee optimum thermal stability. Clamping is performed by a spring. This tailstock is suitable for workpiece weights up to 150 kg.

The centre pressure can be increased with the hydraulically operated tailstock, enabling a workpiece weight between centres of 250 kg.

### Synchronous tailstock

Use of the synchronous tailstock is particularly cost-effective when manufacturing part families, when grinding a workpiece over its entire length or if the use of a conventional driver is not possible.

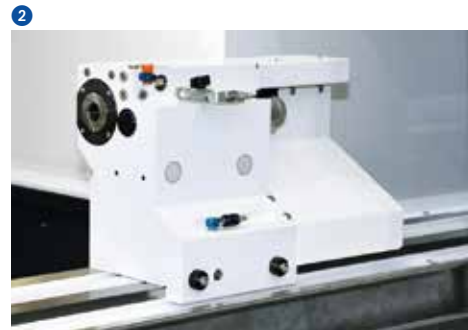

- 1 Tailstock
- 2 Hydraulic tailstock
- 3 Synchronous tailstock

- 4 Fine adjustment for cylindricity corrections

# Dressing

1



An easy-cutting grinding wheel is essential for cost-effective and high-quality grinding. STUDER offers a large selection of dressing units, in order to coordinate the dressing process flexibly and optimally with the properties specific to the workpiece, tool or materials. The grinding wheel profile and dressing parameters are easily defined via macros. Another STUDER speciality is the grinding wheel reference points (T-numbers). This enables programming with normal dimensions, which considerably simplifies the programming of grinding programs.

A software package is available to fine tune the dressing process and includes additional dressing functions.

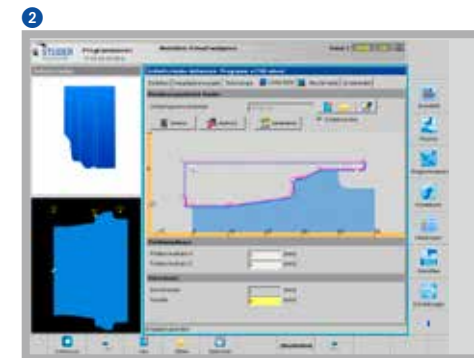

- 1 Swiveling dressing unit
- 2 Dressing parameters dialog screen
- 3 Diamond holder behind tailstock on table



# Control system and operation

1



- PCU manual control unit
- EMC-tested control cabinet
- Ergonomically arranged controls

The S41 is equipped with a 31i-A series Fanuc control with integrated PC. The 15" touch screen facilitates intuitive operation and programming of the machine.

The electrical cabinet is positioned behind the machine. The power and control compartments are spatially separated. The layout of the elements complies with the relevant safety norms and is EMC-tested.

All controls are clearly and ergonomically arranged. An important role is played by the manual control unit, which facilitates setup close to the grinding process.

A special function – the Sensitron electronic contact detection device – reduces downtimes to a minimum.

A free-standing height adjustable operating panel on casters is optionally available.

2



# StuderWIN

1



2

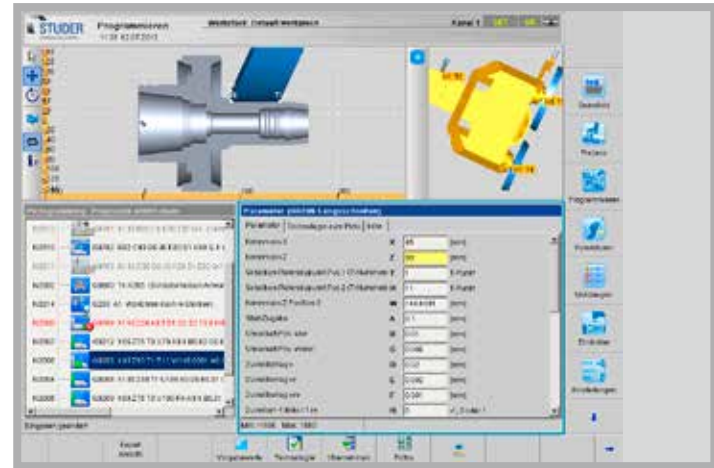

3

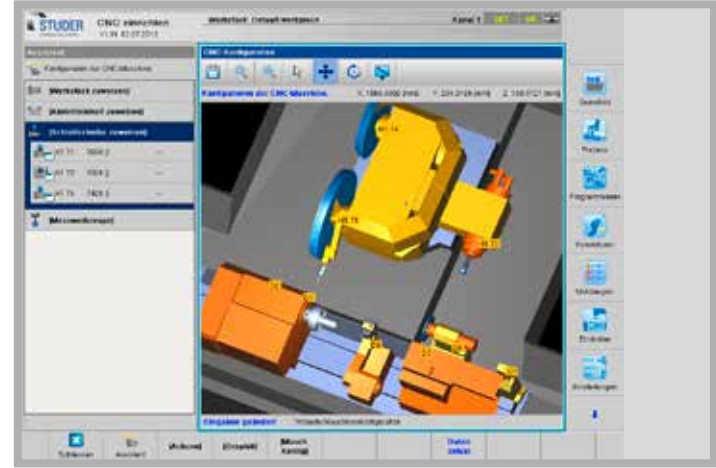

- Latest software technology
- StuderPictogramming

The user interface StuderWIN creates a stable programming environment and contributes to efficient use of the machine. The possibility of fully integrating the in-process gauging and sensor technology for process control as well as contact detection and automatic balancing systems in the operator interface enables standardized programming of the different systems. The software of an optional loading system is also integrated. The drive elements are optimally matched to the control system.

The sophisticated mechanical engineering concept of the S41 is completed by a grinding software program developed in-house by STUDER and which is continuously optimized in collaboration with users of the software. This software offers:

- StuderPictogramming: The operator strings the individual grinding cycles together – the control generates the ISO code.
- STUDER Quick-Set: The software for grinding wheel alignment reduces resetting times by up to 90 %.
- Microfunctions: Free programming of grinding and dressing process sequences for optimization of the grinding process.
- Integrated operating instructions assist safe machine operation.
- The software options for the grinding technology calculations, optimized dressing as well as the Contour-, Thread- and Formgrinding cycles increase the functionality of the machine.



# Process-optimized complete solutions guarantee greater efficiency and reliability throughout.

1



- Automatic production processes
- Integrated quality control
- Standard loader – interfaces

Loading systems are available for the S41, which can be precisely adapted to the machine application and the machining processes thanks to their modular design. The appropriate peripherals ensure seamless integration into the respective production process. The handling systems communicate with the machine via the standardized loader interface and enable even complex handling tasks to be solved. Comprehensive quality control is possible during the grinding process. This entails: in-process, post-process, recording, evaluation and correction. This type of quality assurance is crucial during grinding, but especially during match grinding.

2



3



1 STUDER «easyLoad»  
 2 Working space with workpiece handling  
 3 Post-process station

# Customer Care

STUDER cylindrical grinding machines should fulfil the customer's requirements for as long as possible, work cost-effectively, function reliably and be available at all times. From «start up» through to «retrofit» – our Customer Care is there for you throughout the working life of your machine. 30 professional helplines and more than 60 service technicians are available in your area, wherever you are in the world.

- We will provide you with fast, uncomplicated support.
- We will help to increase your productivity.
- We work professionally, reliably and transparently.
- We will provide a professional solution to your problems.



**Start up**  
 Commissioning  
 Warranty extension



**Qualification**  
 Training  
 Production support



**Prevention**  
 Maintenance  
 Inspection



**Service**  
 Customer service  
 Customer consultation  
 HelpLine  
 Remote service

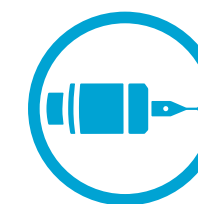

**Material**  
 Spare parts  
 Replacement parts  
 Accessories



**Rebuilt**  
 Machine overhaul  
 Assembly overhaul



**Retrofit**  
 Modifications  
 Retrofits

# Technical Data

## Main dimensions

Distance between centres	1 000 / 1 600 mm (39.4" / 63")
Centre height	225 / 275 mm (8.9" / 10.8")
Max. workpiece weight between centres	250 kg (550 lbs)

## Cross slide: X-axis

Max. travel	350 mm (13.8")
Speed	0.001 – 20 000 mm/min (0.000,04 – 787 ipm)
Resolution	0.00001 mm (0.000,000,4")

## Longitudinal slide: Z-axis

Max. travel	1 150 / 1 750 mm (45.3" / 68.9")
Speed	0.001 – 20 000 mm/min (0.000,04 – 787 ipm)
Resolution	0.00001 mm (0.000,000,4")

## Wheelhead

Swiveling range	-45 to +225 deg
Repetition accuracy	< 1"
Swiveling time for 180°	< 3 s
Resolution	0.00005 deg

## External grinding

Peripheral speed	50 / 80 m/s (9840 / 15 745 sfpm)
Fitting taper	1 : 10 / 73 mm (2.87")
Driving power	15 kW (20 hp)
for 50 m/s	dia. 500 x 80 (100F5) x 203 mm (20" x 3.15" (3.9" F5) x 8")
for 80 m/s	dia. 500 x 50 x 203 mm (20" x 1.9" x 8")

## HSG grinding

Peripheral speed	140 m/s (27 550 sfpm)
Wheel mount	dia. 127 mm (5")
Driving power	30 kW (41 hp)
Grinding wheel	dia. 400 x 40 mm (16" x 1.6")

## Internal grinding

Spindle diameters	dia. 120 / 140 mm (4.72" / 5.51")
Speeds	6 000 – 120 000 rpm

## Options

Length positioning active	
Manual or fully automatic balancing	
Contact detection	

## Universal workhead ISO50

<b>For live spindle grinding or external grinding between centres</b>	
Speed range	1 – 1 000 rpm
Fitting taper / cylindrical external mounting	ISO50 / dia. 110 mm (4.33")
Bar capacity (spindle bore)	dia. 50 mm (1.96")
Driving power	4 kW (5.4 hp)
Load for live spindle grinding	180 Nm (134 ft lbs)
Max. workpiece weight between centres	150 kg (330 lbs)
Roundness during live spindle grinding operations	0.0004 mm (option: 0.0002 mm) (0.000,016" / 0.000,008")

## C-axis for form grinding

– Standard, indirect measuring system	0.0001 deg
---------------------------------------	------------

## Chuck workhead ISO50

<b>For live spindle grinding or external grinding with revolving centre</b>	
Speed range	1 – 1 000 rpm
Fitting taper / cylindrical external mounting	ISO50 / dia. 110 mm (4.33")
Bar capacity (spindle bore)	dia. 50 mm (1.96")
Driving power	4 kW (5.4 hp)
Load for live spindle grinding	250 Nm (186 ft lbs)
Max. workpiece weight between centres	200 kg (440 lbs)
Roundness during live spindle grinding operations	0.0004 mm (option: 0.0002 mm) (0.000,016" / 0.000,008")

## C-axis for form grinding

– Standard, indirect measuring system	0.0001 deg
– High-precision, direct measuring system	0.0001 deg

## Motor workhead

<b>For live spindle grinding or external grinding with revolving centre</b>	
Speed range	1 – 1 500 rpm
Fitting taper / cylindrical external mounting	ISO50 / dia. 110 mm (4.33")
Bar capacity (spindle bore)	dia. 50 mm (1.96")
Driving power	10 kW (13.6 hp)
Load for live spindle grinding	500 Nm (372 ft lbs)
Max. workpiece weight between centres	250 kg (550 lbs)
Roundness during live spindle grinding operations	0.0004 mm (0.000,016")

## C-axis for form grinding

– High-precision, direct measuring system	0.0001 deg
---	------------

## Tailstock

Fitting taper	MT 4
Barrel stroke	60 mm (2.36")
Barrel diameter	60 mm (2.36")
Workpiece weight between centres	150 kg (330 lbs)
Fine adjustment for cylindricity corrections	±80 µm (0.0032")

## Tailstock, hydraulic

Fitting taper	MT 4
Barrel stroke	80 mm (3.15")
Barrel diameter	70 mm (2.75")
Workpiece weight between centres	250 kg (550 lbs)
Fine adjustment for cylindricity corrections	±80 µm (0.0032")

## Synchronous tailstock

Fitting taper	MT 4
Stroke	90 mm (3.54")
Spindle nose	dia. 70 mm (2.76")
Workpiece weight between centres	50 kg (110 lbs)
Fine adjustment for cylindricity corrections	±80 µm (0.0032")

## Control system

Fanuc 31i-A with integrated PC

## Guaranteed working precision

Straightness of the generating line	
Gauge length 950 mm (37.4")	< 0.003 mm (0.000,12")
Gauge length 1 550 mm (61")	< 0.004 mm (0.000,16")

## Connected loads

Total connected load	30 kVA (40 kVA for HSG)
Air pressure	5.5 bar (80 psi)
Extraction capacity for cooling lubricant mist	1 200 – 1 800 m³/h

## Total weight

Distance between centres 1 000 mm (39.4")	9 000 kg (19 800 lbs)
Distance between centres 1 600 mm (63")	10 200 kg (22 440 lbs)

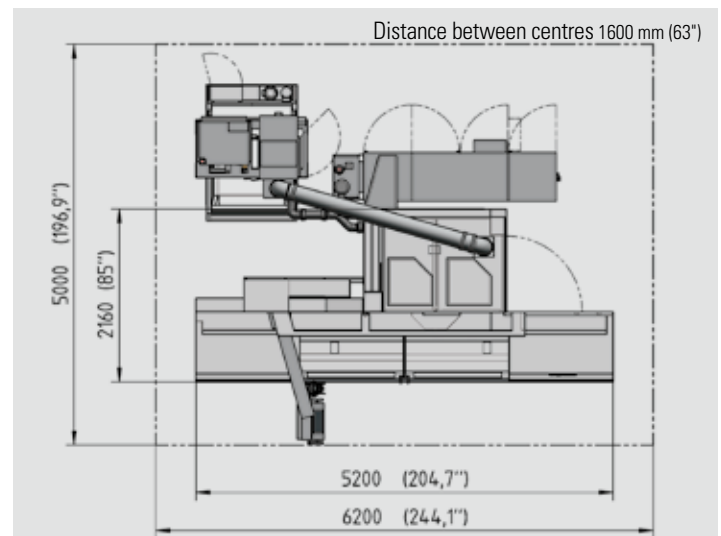
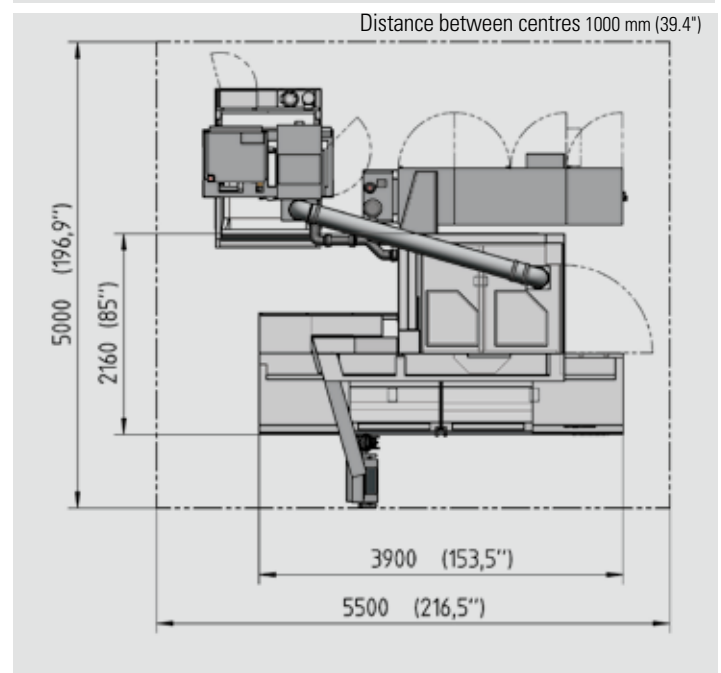
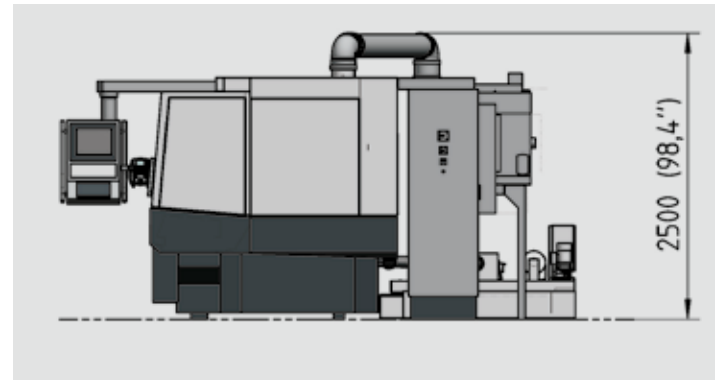

The information given is based on the technical levels of our machine at the time of this brochure going to print. We reserve the right to further develop our machines technically and make design modifications. This means that the dimensions, weights, colours, etc. of the machines supplied can differ. The diverse application possibilities of our machines depend on the technical equipment

specifically requested by our customers. The equipment specifically agreed with the customer is therefore exclusively definitive for the equipping of the machines, and not any general data, information or illustrations.





Fritz Studer AG  
CH-3602 Thun  
Phone +41 33 439 11 11  
Fax +41 33 439 11 12  
info@studer.com  
www.studer.com



**ISO 9001**  
**VDA6.4**  
certified

